



## I-8042W

16-ch Isolated DI and 16-ch Isolated DO Module

### Features

- Digital Input for Sink Type or Source Type
- Digital Output for Sink Type
- Photocouple-Isolation Protection
- Configurable Power-on Value and Safe Value
- 4 kV ESD Protection
- 3750 VDC Intra-module Isolation
- Wide Operating Temperature Range: -25 to +75 °C



### Introduction

I-8042W offers 16 channels for Digital Input and 16-Channel for Digital Output. Each of which features Photocouple-isolation. I-8042W supports Sink Type Output with short-circuits protection.

There are option for Power-on value and safe value for your consideration. About Input, you can chose Sink Type or Source Type input by wire connection. I-8042W also has 32 LED indicators for channel status. ±4 kV ESD protection and 3750 VDC intra-module isolation are standard.

### System Specifications

LED Display	
System LED Indicator	1 LED as Power Indicator
I/O LED Indicator	32 LEDs as Digital Input Indicators
Isolation	
Intra-module Isolation, Field-to-Logic	3750 VDC
EMS Protection	
ESD (IEC 61000-4-2)	±4 kV Contact for each Terminal
Power	
Power Consumption	1.5 W Max.
Mechanical	
Dimensions (W x L x H)	30 mm x 85 mm x 114 mm
Environment	
Operating Temperature	-25 ~ +75 °C
Storage Temperature	-40 ~ +85 °C
Humidity	10 ~ 90% RH, Non-condensing

### I/O Specifications

Digital Input	
Channels	16
Sink/Source	Sink, Source
Input Type	Wet
ON Voltage Level	+10 VDC ~ +30 VDC
OFF Voltage Level	+4 VDC Max.
Input Impedance	3 KΩ, 0.33 W
Digital Output	
Channels	16
Sink/Source (NPN/PNP)	Sink
Output Type	Isolated Open Collector
Max. Load Current	100 mA/Channel
Load Voltage	+5 VDC ~ +30 VDC
Overload Protection	1.1 A
Power-on Value	Yes
Safe Value	Yes

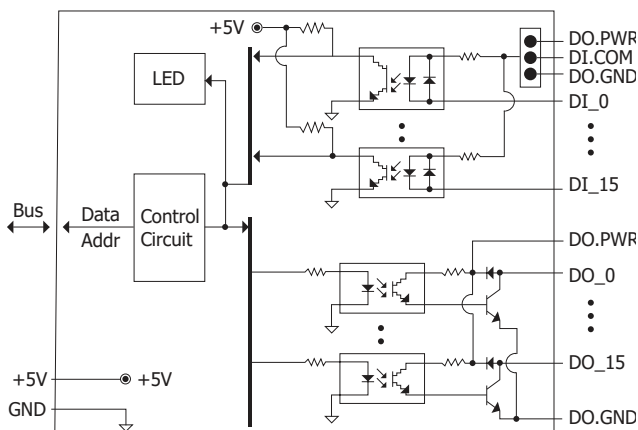

### Internal I/O Structure

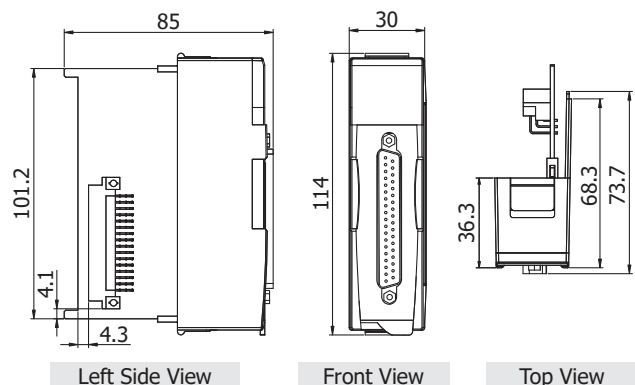

### Dimensions (Units: mm)







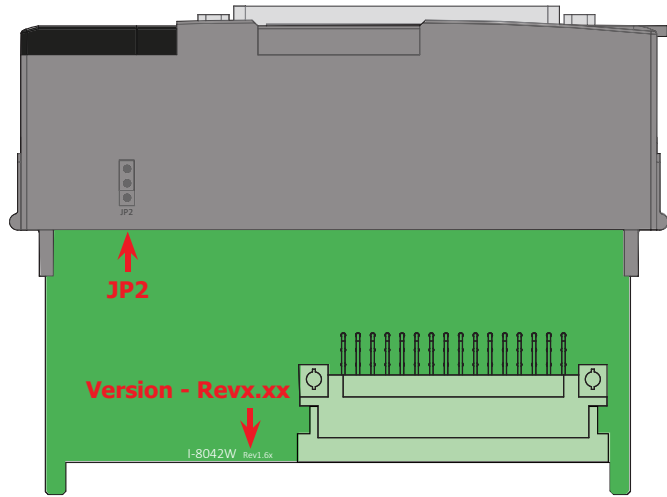











## Input Signal Selection

Input Type	
JP2 Jumper Selection (Rev1.61)	
Sink	Source (Default)
EXT.GND DI.COM EXT.PWR  <b>JP2</b>	EXT.GND DI.COM EXT.PWR  <b>JP2</b>



## Wire Connections

Input Type	ON State LED ON Readback as 1	OFF State LED OFF Readback as 0
<b>Sink (DI.COM Connect with EXT.GND)</b>		
	Relay ON	Relay OFF
Relay Contact		
	Voltage > +3.5 V	Voltage < +1 V
TTL/CMOS Logic		
	Open Collector ON	Open Collector OFF
NPN Output		
	Open Collector ON	Open Collector OFF
PNP Output		
<b>Source (DI.COM Connect with EXT.PWR)</b>		
	Relay ON	Relay OFF
Relay Contact		
	Voltage > +3.5 V	Voltage < +1 V
TTL/CMOS Logic		
	Open Collector ON	Open Collector OFF
NPN Output		
	Open Collector ON	Open Collector OFF
PNP Output		

## Wire Connections

Output Type	ON State LED ON Readback as 1	OFF State LED OFF Readback as 0
Drive Relay	Relay ON 	Relay OFF 
	Relay ON 	Relay OFF 
Resistance Load		

## Pin Assignments

Pin Assignment	Terminal No.	Pin Assignment
DI.COM/DO.PWR	19	DI.COM/DO.PWR
DO.PWR	18	DO.PWR
DO.GND	17	DO.GND
DI_15	16	DI_15
DI_14	15	DI_14
DI_13	14	DI_13
DI_12	13	DI_12
DI_11	12	DI_11
DI_10	11	DI_10
DI_9	10	DI_9
DI_8	09	DI_8
DI_7	08	DI_7
DI_6	07	DI_6
DI_5	06	DI_5
DI_4	05	DI_4
DI_3	04	DI_3
DI_2	03	DI_2
DI_1	02	DI_1
DI_0	01	DI_0

37-pin Male D-Sub Connector

## Accessories

### DN-8K16P16R CR

16-channel digital input terminal and 16-channel relay output board (RoHS)

Female DB37 to Screw Terminal Board (Pitch= 3.81 mm) with DIN-rail Mounting for I-8042W or I-87042W

Include: CA-3705A (DB37 Male to Female Cable, 90°, 50 CM)

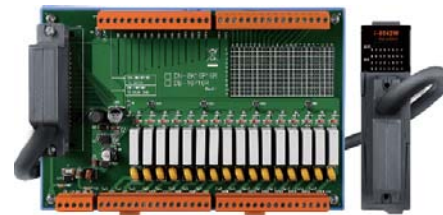

I-8042W with DN-8K16P16R

### DN-37-381-A CR

Female DB37 to Screw Terminal Board (Pitch=3.81 mm) with DIN-rail Mounting (RoHS)

Include: CA-3710A (DB37 Male to Female, 90°, 1M)



I-8042W with DN-37-381-A

## Ordering Information

<b>I-8042W CR</b>	16-ch Isolated DI and 16-ch Isolated DO I/O Module (RoHS)
-------------------	---

### DN-37-A CR

Female DB37 to Screw Terminal Board (Pitch= 5.08 mm) with DIN-rail Mounting (RoHS)

Include: CA-3710A (DB37 Male to Female, 45°, 1M)