



CL-201-E
CL-202-E
CL-203-E
CL-204-E
CL-205-E
CL-206-E
CL-207-E
CL-208-E

Remote CO/CO₂/NH₃/H₂S/HCHO/TVOC/Temperature/
Humidity/Dew Point Data Logger Module

Features

- Able to record CO, CO₂, H₂S, NH₃, HCHO, TVOC, Temperature, Humidity and Dew Point Measurements
- Non-dispersive Infrared (NDIR) CO₂ Sensor
- HCHO : Electrochemical Sensor
- VCO : Metal-Oxide Sensor
- Up to 450,000 records with date and time stamps
- Simple and Powerful Software Utility, iOS APP and Android App Included
- Supports the DCON, Modbus RTU/TCP, and MQTT Protocols
- Includes RS-485/Ethernet Communication Interfaces
- Relay Output for Alarm or IAQ Device Control
- Ceiling Mounting or Wall Mounting



Introduction

The CL-200 series of data logger devices can be used to record CO, CO₂, NH₃, H₂S, HCHO, TVOC, temperature, humidity and dew point information, including the date and time stamps, and are able to store up to 450,000 downloadable records. Real-time data can be accessed from the CL-200 data logger from anywhere and at any time using the free Windows software, the Iso App, or the Android App, as long as they are connected to the same local network as the data logger. Support is provided for common industrial protocols such as DCON, Modbus RTU, and Modbus TCP, as well as the emerging machine to-machine (M2M)/IoT (Internet of Things) connectivity protocol – MQTT. The CL-200 data logger can be connected via widely used communication interfaces including RS-485, Ethernet and PoE, meaning that the device can be easily integrated into existing HMI or SCADA systems, ensuring trouble-free maintenance in distributed control systems.

Supports the MQTT Protocol for IoT Applications

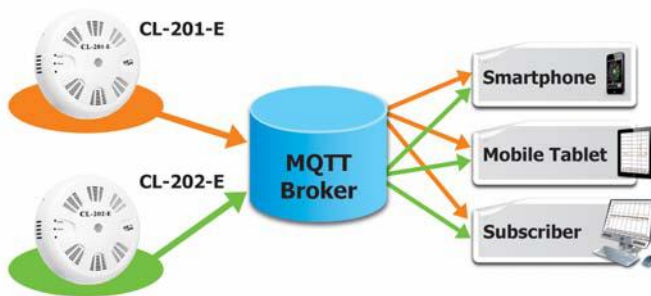

Multi-platform Remote Access Software

Real-time data from the CL-200 data logger can be accessed from anywhere and at any time using the DL300 Utility, the iOS or Android App, or via a regular web browser, as long as they are connected to the same local network as the data logger.



Simple and Powerful DL-300 Utility

The DL-300 Utility is a powerful tool that is designed for configuring the modules, monitoring real-time data, grouping DL-300 and CL-200 modules to view and manage the status of distribution groups, downloading log data, which can be exported to a CSV file that can then be imported into any industry-standard software or spreadsheet for analysis.

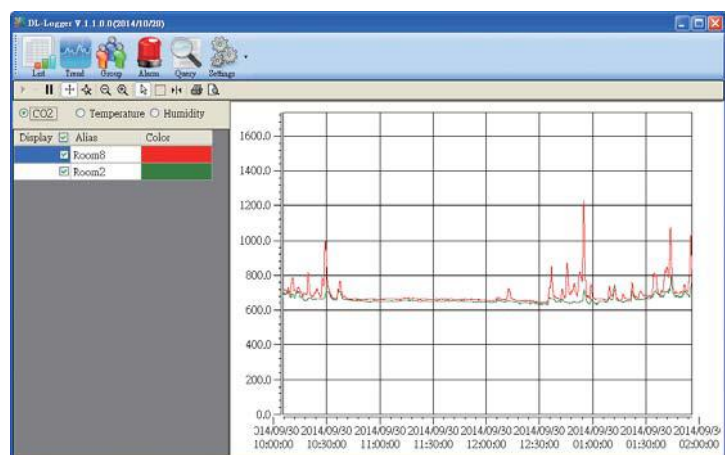

System Specifications

Model	CL-201-E	CL-202-E	CL-203-E	CL-204-E	CL-205-E	CL-206-E	CL-207-E	CL-208-E	
System									
CO Alarm	Yes	-	Yes	-					
CO2 Alarm	-	Yes	Yes	-					
HCHO Alarm	-			Yes	-		Yes	-	
TVOC Alarm	-			Yes	-			Yes	
NH3 Alarm	-				Yes	-			
H2S Alarm	-				-		Yes	-	
RH/Temperature Alarm	Yes								
Real Time Clock	Yes								
Data Logger	Yes, up to 450,000 records								
Relay Output	Form A x1, SPST 30 VDC @ 16 A or 250 VAC @ 16 A								
Interface	RS-485/Ethernet								
Electrical									
Powered from Terminal Block	+12 to +48 VDC								
Power Consumption	Non-PoE	1.5 W (Max.)	1.5 W (Max.)	1.6 W (Max.)	1.9 W (Max.)	1.6 W (Max.)	1.6 W (Max.)	1.9 W (Max.)	1.9 W (Max.)
	PoE	1.6 W (Max.)	1.6 W (Max.)	1.7 W (Max.)	2.0 W (Max.)	1.7 W (Max.)	1.7 W (Max.)	2.0 W (Max.)	2.0 W (Max.)
Mechanical									
Installation	Ceiling Mounting/Wall Mounting								
Protection Class	IP20								
Dimensions (D x H)	Ø 150 mm x 53 mm								
Environment									
Operating Temperature	0 to +50°C								
Storage Temperature	-30 to +75°C								
Humidity	10 to 90% RH, Non-condensing								

I/O Specifications

Model	CL-201-E	CL-202-E	CL-203-E	CL-204-E	CL-205-E	CL-206-E	CL-207-E	CL-208-E
CO Measurement								
Range	0 to 1000 ppm (Electrochemical)	-	0 to 1000 ppm (Electrochemical)	-				
Resolution	1 ppm	-	1 ppm	-				
Accuracy	±5% of measured value	-	±5% of measured value	-				
Response Time	30 seconds	-	30 seconds	-				
Warm-up Time	60 seconds	-	60 seconds	-				
CO2 Measurement								
Range	-	0 to 9999 ppm (NDIR)			-			
Resolution	-	1 ppm			-			
Accuracy	-	±40 ppm ±3% of measured value			-			
Response Time	-	120 seconds			-			
Warm-up Time	-	5 minutes			-			
NH3 Measurement								
Range	-				0 to 100 ppm (Electrochemical)	-		
Resolution	-				1 ppm	-		
Accuracy	-				±5% of measured value	-		
Response Time	-				< 120 Sec	-		
Warm-up Time	-				180 Sec	-		

I/O Specifications

Model	CL-201-E	CL-202-E	CL-203-E	CL-204-E	CL-205-E	CL-206-E	CL-207-E	CL-208-E
H2S Measurement								
Range			-			0 to 100 ppm (Electrochemical)		-
Resolution			-			1 ppm		-
Accuracy			-			±5% of measured value		-
Response Time			-			< 120 Sec		-
Warm-up Time			-			180 Sec		-
HCHO Measurement								
Range		-		0 to 2000 ppm (Electrochemical)		-	0 to 2000 ppm (Electrochemical)	-
Resolution		-		1 ppm		-	1 ppm	-
Accuracy		-		-		-	-	-
Response Time		-		≤60 seconds		-	≤60 seconds	-
Warm-up Time		-		180 seconds		-	180 seconds	-
TVOC Measurement								
Range		-		0 ppb to 60000 ppb (MEMS Metal Oxide)				0 ppb to 60000 ppb (MEMS Metal Oxide)
Resolution		-		1 ppb				1 ppb
Accuracy		-		±15%				±15%
Response Time		-		60 seconds				60 seconds
Warm-up Time		-		180 seconds				180 seconds
Temperature Measurement								
Range	-10 to +50°C							
Resolution	0.1°C							
Accuracy	±0.6°C							
Relative Humidity Measurement								
Range	0 to 100% RH, Non-condensing							
Resolution	0.1% RH, Non-condensing							
Accuracy	±5% RH, Non-condensing							
Dew Point								
Range	Calculated using temperature and relative humidity							
Resolution	0.1°C							

Pin Assignments & Wire Connections

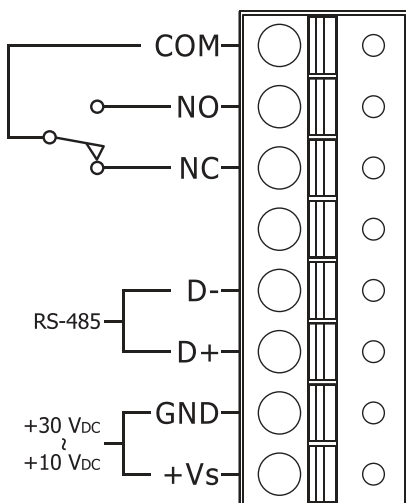

DIP Switch Settings

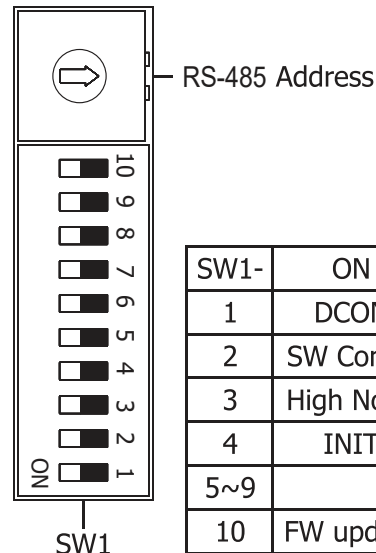

SW1-	ON	OFF
1	DCON	Modbus
2	SW Config	HW Config
3	High Node	Low Node
4	INIT	RUN
5~9	Reserved	
10	FW update	Null

Dimensions (Units: mm)

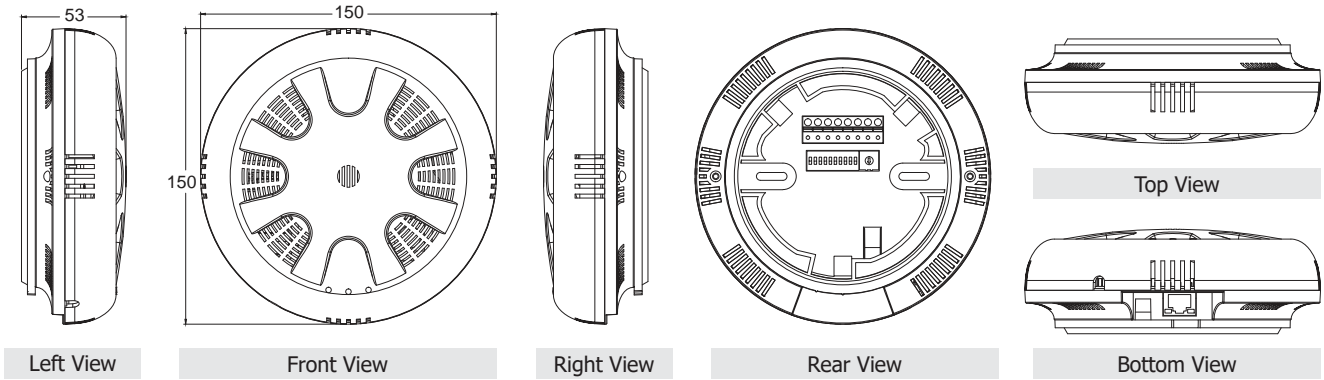

Installation

Ceiling Mounting

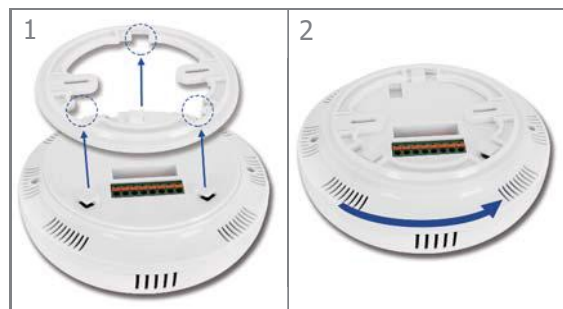

Wall Mounting (+ External Wall Box EWB-C150)

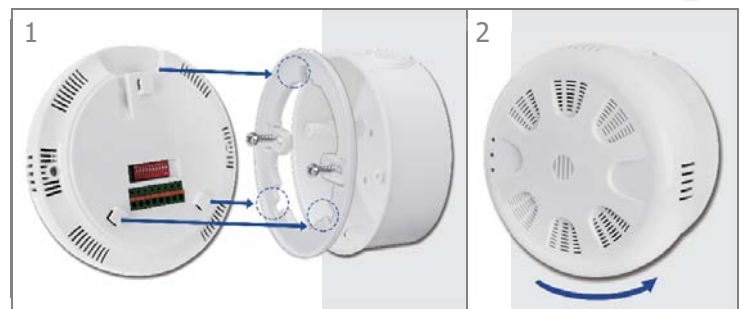

CL-2xx-E + RJ45 Cable:

CL-2xx-E (Ethernet Type) are with optional angle-bent RJ45 cable to smoothly install the Ethernet plug in the hole of the ceiling-mounted.

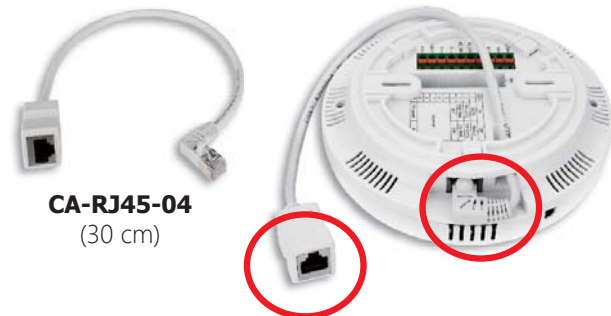

Applications

- Transportation of Food or Pharmaceuticals
- Blood Stations and Pharmacies
- Warehouse Management
- Food and Beverage Industry (HACCP)
- Building and Energy Management
- Museums, Archives and Galleries

Indoor or Underground Parking Lot Automatic Monitoring Solution

The air quality automation system for indoor or underground parking lot can use the CL-200 series modules to monitor the health and safety information, such as CO, CO₂, temperature, humidity, dew point, and more...



■ HCHO (Formaldehyde) / VOC Detector Automatic Solution

The HCHO/VOC detector provides an instantaneously warning of toxic formaldehyde, which can be found in a plywood factory, furniture factory and new interior remodelling house commonly.

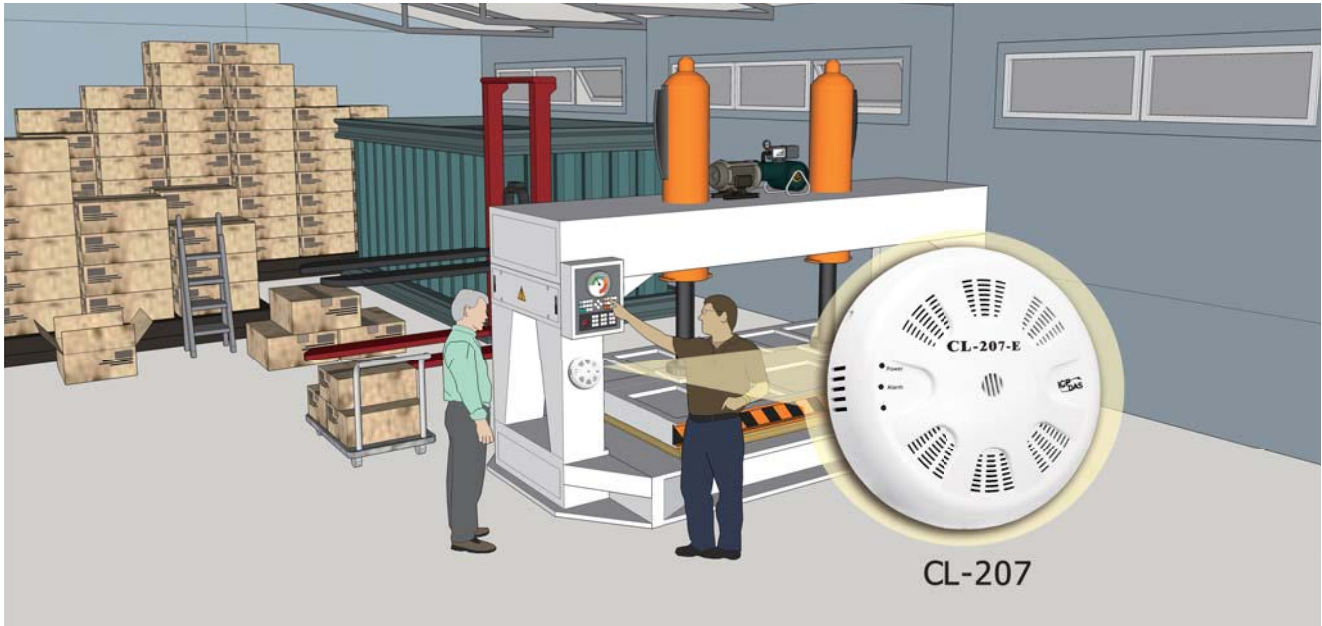

■ Preschool Air Quality Monitoring

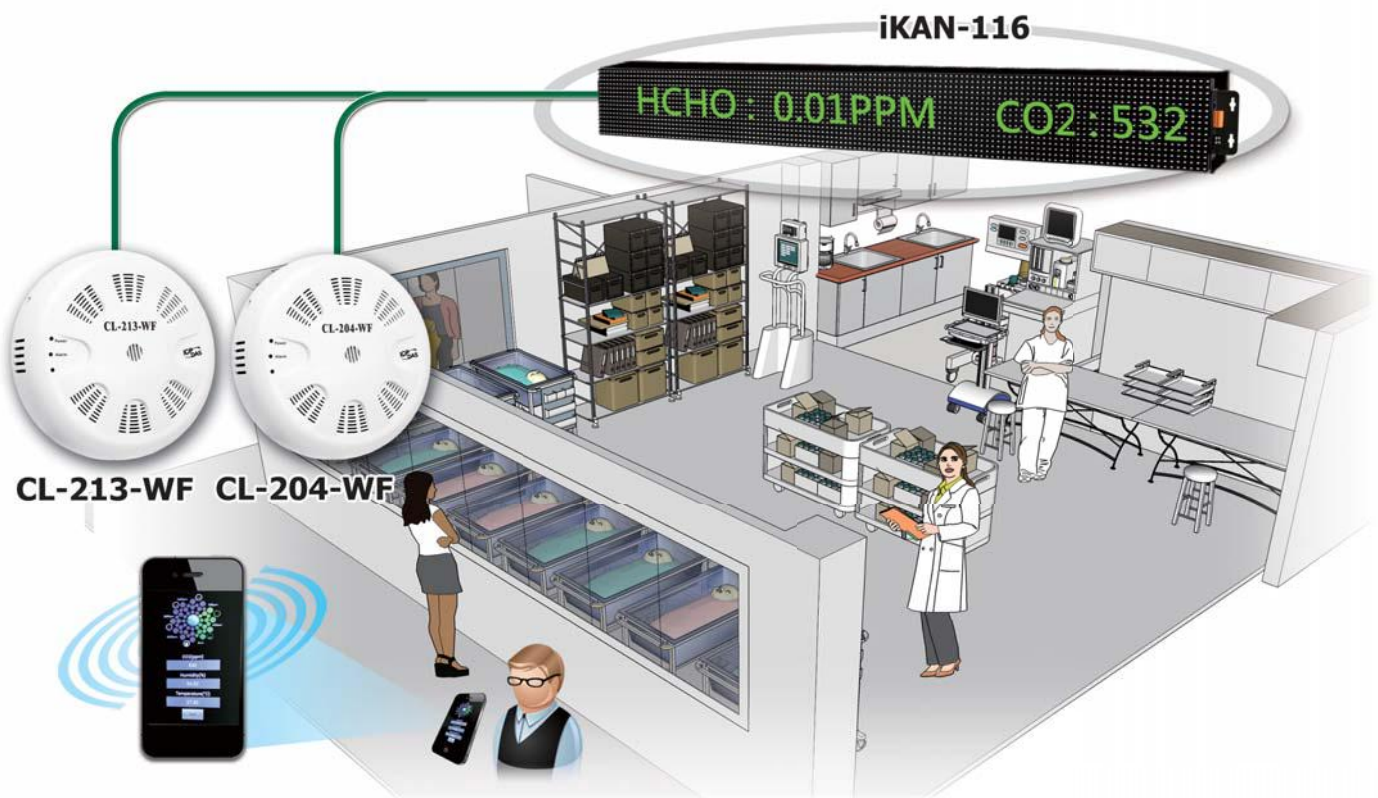

Indoor air quality is a key matter for children in preschool. ICP DAS provide a solution toward this environment include CL-213-E, CL-204-E modules to monitor the fumes and Particle Matters such as PM1, PM2.5, PM10, CO, CO2, HCHO, TVOC, and etc. Combine with ICP DAS iKAN series LED monitors, teachers in the preschool can easily check the real-time Air Quality Index. Furthermore, diversity of SCADA software is also compatible with these monitoring modules and can upload received data into remote database. Teachers can use their mobile App to remotely check the AQI or other fumes data to make sure that the Air Quality is always in the safety range.



Ordering Information

CL-201-E CR	Remote CO/Temperature/Humidity/Dew Point Data Logger with Ethernet/RS-485 Interfaces and PoE (RoHS)
CL-202-E CR	Remote CO ₂ /Temperature/Humidity/Dew Point Data Logger with Ethernet/RS-485 Interfaces and PoE (RoHS)
CL-203-E CR	Remote CO/CO ₂ /Temperature/Humidity/Dew Point Data Logger with Ethernet/RS-485 Interfaces and PoE (RoHS)
CL-204-E CR	Remote HCHO/TVOC/Temperature/Humidity/Dew Point Data Logger with Ethernet/RS-485 Interfaces and PoE (RoHS)
CL-205-E CR	Remote NH ₃ /Temperature/Humidity/Dew Point Data Logger with Ethernet/RS-485 Interfaces and PoE (RoHS)
CL-206-E CR	Remote H ₂ S /Temperature/Humidity/Dew Point Data Logger with Ethernet/RS-485 Interfaces and PoE (RoHS)
CL-207-E CR	Remote HCHO/Temperature/Humidity/Dew Point Data Logger with Ethernet/RS-485 Interfaces and PoE (RoHS)
CL-208-E CR	Remote TVOC/Temperature/Humidity/Dew Point Data Logger with Ethernet/RS-485 Interfaces and PoE (RoHS)

Accessories

EWB-C150		External Wall Box for the CL-200 series
CA-RJ45-04		RJ45 Cable, Male-Female, 30cm (90°)